

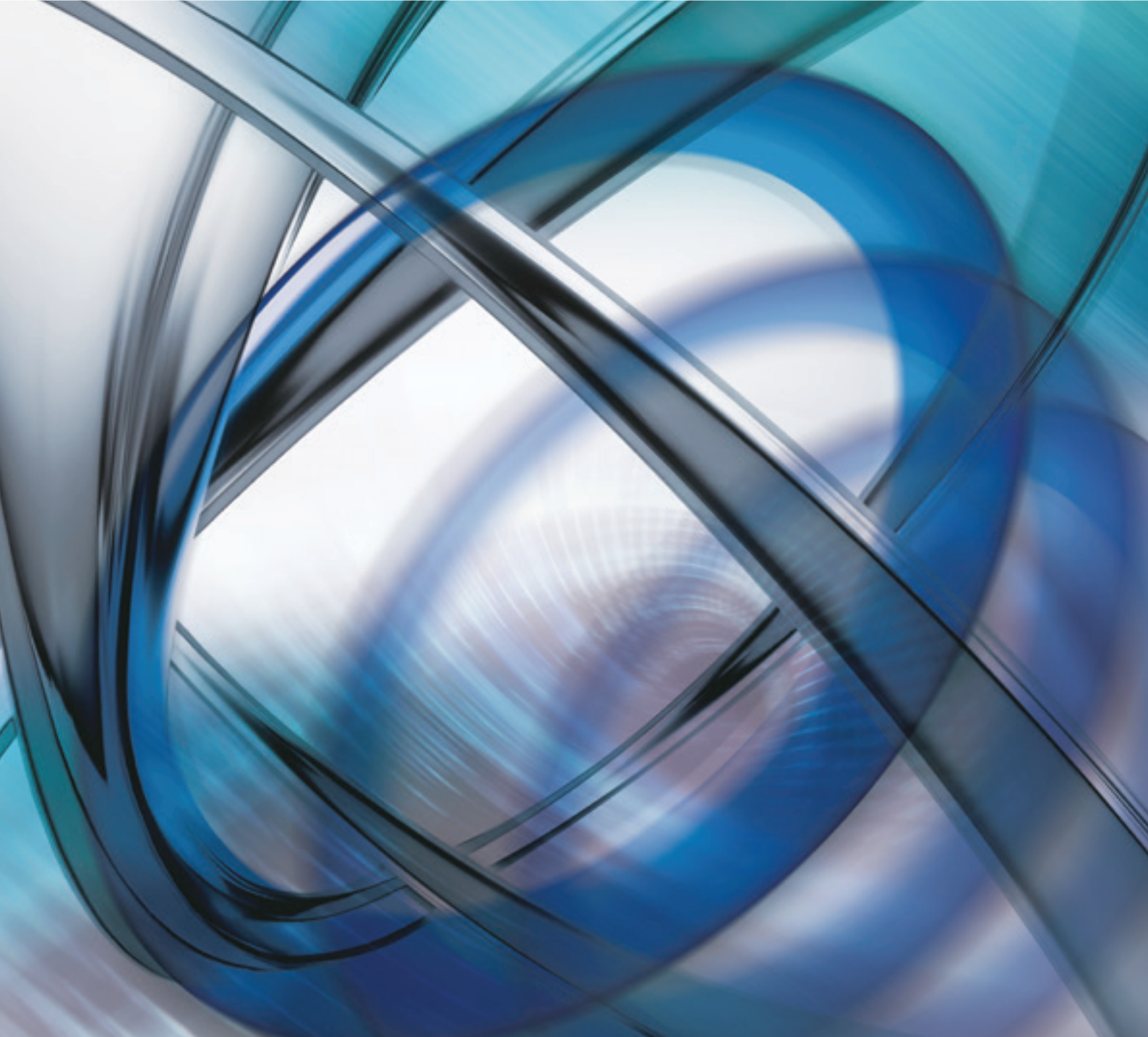

Power Transmission and Conveyor Belt
PolyBelt™



NITTA CORPORATION

Features

Nitta Corporation has developed “ PolyBelt ” to meet the demands of its customers in the power transmission field, offering a wide variety of types.

These products have delivered proven results in power transmission for industrial machinery used in the textile, paper manufacturing and flour-milling industries. Nitta has also provided the best types of PolyBelt for conveying applications on printing and box-making machines.

PolyBelt, which is basically made up of a combination of thin and strong polyamide film and highly abrasion-resistant special rubber, is widely used in industry.

Nitta’s mission is to deliver high quality and reliable products and to meet the needs of its customers in the fast-changing industrial market.

CONTENTS

	Page
■ Features	2
■ Types and Properties	3 to 6
■ Design Materials	7 to 10
Biaxial Power Transmission Design	7 to 9
Belt Length Calculation Formula	10
Pulley Shape	10
■ Precautions for Use	11 to 13
Troubleshooting for Power Transmission Problems	13
■ For Safe Use of Products	14

1 Abrasion resistance

Excellent abrasion resistance achieved due to the stable friction coefficient provided by use of special synthetic rubber (NBR: Acrylonitrile Butadiene Rubber).

(Taber Abrasion Test: 40 mg/1000 times)

*Abrasive wheel used: H22, Load: 5N

2 High-tensile tension member

High-quality stretched polyamide film is used as a tension member to provide high tensile strength.

(Tensile strength of the polyamide film tension member: 300 Mpa (3,000 kgf/cm²) or more)

3 High-speed power transmission

High flex resistance and high-speed power transmission obtained by using a thin and strong tension member to reduce the effect of centrifugal forces.

(Up to 70 m/s available)

4 Antistatic treatment

PolyBelt (except as noted) is subjected to antistatic treatment to obtain low electrostatic potential.

(500 V or less)

5 Wide variety of types

Wide variety of types available to meet the demands in all fields including power transmission and conveyance.

6 Easy endless joining

On-site endless joining of belts is easy with Nitta’s special tools and adhesives.

Types and Properties

Major Applications	Properties	Belt Type		Total Thickness (mm)	Tension Member Thickness (mm)	Weight (kg/m ²)	Cover Material								Axial load under stable conditions (N/mm width; kgf/cm width)		Minimum pulley diameter (mm)		Antistatic property	Standard maximum width (mm)	Temperature range for continuous use (°C) (For intermittent use)		
							Top surface				Bottom surface												
							Material	Surface configuration	Color	Friction coefficient	Material	Surface configuration	Color	Friction coefficient	At 2% elongation	At 1% elongation	For power transmission	For conveyance					
General power transmission Paper feed section of the printing machine Plywood conveyor	Moderate sliding properties on both sides	SG	250	0.8	0.2	0.8		NBR	Weave	Green	0.3 to 0.4	NBR	Weave	Black	0.3 to 0.4	6.0	3.0	25	20	○	300	-20 to +80 (-30 to +100)	
			350	0.95	0.35	0.9		NBR	Weave	Green		NBR	Weave	Black		10.5	5.2	35	30	○			300
			500	1.1	0.5	1.1		NBR	Weave	Green		NBR	Weave	Black		15.0	7.5	50	40	○			300
			750	1.35	0.75	1.4		NBR	Weave	Green		NBR	Weave	Black		22.5	11.2	75	50	○			300
			1000	1.6	1.0	1.7		NBR	Weave	Green		NBR	Weave	Black		30.0	15.0	100	60	○			300
Machine tools (automatic lathes, etc.) Dryers (cylinder drying machine, etc.) Small to medium wood working machines Small centrifugal pumps and blowers	Thin rubber especially suitable for flexing/high-speed operation	L	250	1.25	0.2	1.4		NBR	Weave	Blue	0.5 to 0.6 (Against iron)	NBR	Weave	Black	0.5 to 0.6 (Against iron)	6.0	3.0	25	20	○	300	-20 to +80 (-30 to +100)	
			350	1.4	0.35	1.6		NBR	Weave	Blue		NBR	Weave	Black		10.5	5.2	35	30	○			300
			500	1.55	0.5	1.8		NBR	Weave	Blue		NBR	Weave	Black		15.0	7.5	50	40	○			300
			750	2.2	0.75	2.5		NBR	Weave	Blue		NBR	Weave	Black		22.5	11.2	75	50	○			300
			1000	2.45	1.0	2.8		NBR	Weave	Blue		NBR	Weave	Black		30.0	15.0	100	60	○			300
			1500	2.95	1.5	3.4		NBR	Weave	Blue		NBR	Weave	Black		45.0	22.5	150	90	○			300
Power transmission in industrial machinery (fans, pumps, etc.) Sawmill machines (chippers, etc.) Paper working machines (coaters, etc.) Other power transmission Cut-proof conveyors (thin-plate conveyors, etc.)	Standard type Suitable for normal operating conditions	M	250	2.2	0.2	2.4		NBR	Weave	Blue	0.5 to 0.6 (Against iron)	NBR	Weave	Black	0.5 to 0.6 (Against iron)	6.0	3.0	25	25	○	300	-20 to +80 (-30 to +100)	
			350	2.35	0.35	2.6		NBR	Weave	Blue		NBR	Weave	Black		10.5	5.2	35	35	○			300
			500	2.5	0.5	2.7		NBR	Weave	Blue		NBR	Weave	Black		15.0	7.5	50	40	○			300
			750	2.75	0.75	3.0		NBR	Weave	Blue		NBR	Weave	Black		22.5	11.2	75	50	○			300
			1000	3.0	1.0	3.3		NBR	Weave	Blue		NBR	Weave	Black		30.0	15.0	100	60	○			300
			1500	3.5	1.5	4.0		NBR	Weave	Blue		NBR	Weave	Black		45.0	22.5	150	90	○			300
Compressors Rolling machines Paper tube winding machines Abrasion-resistant conveyors (building material conveyors, etc.)	Highly abrasion/impact resistant thick rubber cover is used. Suitable for severe operating conditions etc.)	H	500	3.5	0.5	3.8		NBR	Weave	Blue	0.5 to 0.6 (Against iron)	NBR	Weave	Black	0.5 to 0.6 (Against iron)	15.0	7.5	50	50	○	300	-20 to +80 (-30 to +100)	
			750	3.75	0.75	4.1		NBR	Weave	Blue		NBR	Weave	Black		22.5	11.2	75	60	○			300
			1000	4.0	1.0	4.4		NBR	Weave	Blue		NBR	Weave	Black		30.0	15.0	100	75	○			300
			1500	4.5	1.5	5.0		NBR	Weave	Blue		NBR	Weave	Black		45.0	22.5	150	120	○			300
			2000	5.0	2.0	5.6		NBR	Weave	Blue		NBR	Weave	Black		60.0	30.0	200	160	○			300
		MH	2500	5.0	2.5	6.0		NBR	Weave	Blue	NBR	Weave	Black	0.5 to 0.6	75.0	37.5	250	—	○	300			
			3000	5.5	3.0	6.5		NBR	Weave	Blue	NBR	Weave	Black	0.5 to 0.6	90.0	45.0	300	—	○	300			
			4000	6.5	4.0	7.6		NBR	Weave	Blue	NBR	Weave	Black	(Against iron)	120.0	60.0	400	—	○	300			

Major Applications	Properties	Belt Type		Total Thickness (mm)	Tension Member Thickness (mm)	Weight (kg/m ²)	Cover Material								Axial load under stable conditions (N/mm width; kgf/cm width)		Minimum pulley diameter (mm)		Antistatic property	Standard maximum width (mm)	Temperature range for continuous use (°C) (For intermittent use)
							Top surface				Bottom surface				At 2% elongation	At 1% elongation	For power transmission	For conveyance			
							Material	Surface configuration	Color	Friction coefficient	Material	Surface configuration	Color	Friction coefficient							
Corrugated board machines (Paper feeding to and discharging from the rotary cutter)	Highly scratch/abrasion resistant surface material used	CBX-7S		4.2	0.75	2.5	Artificial leather	Flat and smooth	Gray	0.4 to 0.5 (Against cardboard)	Artificial leather	Flat and smooth	Gray	0.2 to 0.25 (Against SUS)	—	15.0	—	75	—	300	-20 to +80
Box making machines (Counter eject)	High gripping force and abrasion resistance	CBE-20		Approx.7.0	—	5.9	NBR	Rough top	Blue	Approx. 1.0 (Against cardboard)	Polyester	Canvas	Black	0.2 to 0.25 (Against SUS)	—	6.0 (0.5%)	—	100	○	300	-20 to +80
For conveying cardboard boxes	Table-supported high speed conveyance possible	CBG-7S		3.5	0.75	3.5	NBR	Rough	Blue	0.7 to 0.8 (Against cardboard)	Polyamide	Canvas	Blue	0.2 to 0.25 (Against SUS)	—	15.0	—	75	○	300	-20 to +80
Conveying cardboard boxes Conveying plywood	High conveyance capacity achieved due to rough top cover	NRT	0	Approx.5.5	—	4.8	NBR	Rough top	Blue	Approx. 1.0 (Against cardboard)	Polyester	Canvas	White	0.2 to 0.25 (Against SUS)	—	1.3	—	100	○	300	-20 to +80 (-30 to +100)
			100	Approx.4.5	—	3.6	NBR	Rough top	Blue	Approx. 1.0 (Against cardboard)	Polyester	Canvas	White	0.2 to 0.25 (Against SUS)	—	6.0 (0.5%)	—	50	○	300	
	Suitable for severe operating conditions	300	Approx.6.5	—	6.5	NBR	Rough top	Blue	Approx. 1.0 (Against cardboard)	Polyester	Canvas	White	0.2 to 0.25 (Against SUS)	—	6.0 (0.5%)	—	100	○	300		
		500	Approx.6.0	0.5	5.6	NBR	Rough top	Blue	Approx. 1.0 (Against cardboard)	NBR	Canvas	Black	0.2 to 0.25 (Against SUS)	—	7.5	—	90	○	300		
		RT	300	Approx.7.0	—	6.5	NBR	Rough top	Blue	Approx. 1.0 (Against cardboard)	Polyester	Canvas	White	0.2 to 0.25 (Against SUS)	—	6.0 (0.5%)	—	100	○	300	
Printer paper feed	Top surface has high friction coefficient Bottom surface has excellent sliding properties	IRTA	350	1.15	0.35	1.2	NBR	Weave	Green	0.5 to 0.6	Polyamide	Canvas	Blue	0.2 to 0.3	10.5	5.2	—	30	○	300	-20 to +80
		KCS	350	1.1	0.35	0.8	NBR	Weave	Black	0.3 to 0.4	Polyamide	Canvas	Blue	0.2 to 0.3	10.5	5.2	—	30	○	300	(-30 to +100)
Folder gluer Conveying plywood	High conveyance capacity achieved due to rubber properties	XH	500-3	3.0	0.5	3.4	NBR	Weave	Blue	—	NBR	Weave	Blue	—	15.0	7.5	—	50	○	300	-20 to +80 (-30 to +100)
			500-3.5	3.5	0.5	3.9	NBR	Weave	Blue	0.8	NBR	Weave	Blue	0.7	15.0	7.5	—	55	○	300	
			500-4	4.0	0.5	4.3	NBR	Weave	Blue	to	NBR	Weave	Blue	to	15.0	7.5	—	60	○	300	
			500-6	6.0	0.5	7.4	NBR	Weave	Blue	0.9	NBR	Weave	Blue	0.8	15.0	7.5	—	80	○	300	
			750-4	4.0	0.75	4.4	NBR	Weave	Blue	—	NBR	Weave	Blue	(Against SUS)	22.5	11.2	—	75	○	300	
			1000-4	4.0	1.0	4.4	NBR	Weave	Blue	—	NBR	Weave	Blue	—	30.0	15.0	—	75	○	300	
Table-supported conveyor Stopper conveyor	Excellent sliding on both surfaces	TTA	500N	1.3	0.5	1.2	Polyamide	Canvas	Blue	0.2 to 0.3	Polyamide	Canvas	Blue	0.2 to 0.3	15.0	7.5	—	40	—	300	-20 to +80
			1000N	1.8	1.0	1.7	Polyamide	Canvas	Blue	0.2 to 0.3	Polyamide	Canvas	Blue	0.2 to 0.3	30.0	15.0	—	60	—	300	(-30 to +100)
		TTB	1000	2.8	1.0	2.5	Polyamide	Canvas	Blue	0.2 to 0.3	Polyamide	Canvas	Blue	0.2 to 0.3	30.0	15.0	—	60	—	300	
Table-supported conveyor	Excellent sliding on one surface	GLTB	500	2.05	0.5	2.0	NBR	Weave	Blue	0.5 to 0.6	Polyamide	Canvas	Blue	0.2 to 0.3	15.0	7.5	—	40	○	300	-20 to +80
			1000	2.75	1.0	2.6	NBR	Weave	Blue	0.5 to 0.6	Polyamide	Canvas	Blue	0.2 to 0.3	30.0	15.0	—	60	○	300	(-30 to +100)
		GMTB	1000	3.0	1.0	2.9	NBR	Weave	Blue	0.5 to 0.6	Polyamide	Canvas	Blue	0.2 to 0.3	30.0	15.0	—	60	○	300	
Sloping conveyor	High conveyance capacity achieved due to rough surface of belt	TW	250	1.8	0.2	1.5	NBR	Rough weave	Blue	—	NBR	Weave	Black	0.5 to 0.6	6.0	3.0	—	25	○	300	-20 to +80
			500	2.1	0.5	1.9	NBR	Rough weave	Blue	—	NBR	Weave	Black	0.5 to 0.6	15.0	7.5	—	40	○	300	(-30 to +100)
		TWH	500	3.8	0.5	3.8	NBR	Rough weave	Blue	—	NBR	Weave	Black	0.5 to 0.6	15.0	7.5	—	40	○	300	

1. Biaxial Power Transmission Design

(1) Select the belt type according to the design power and the small pulley rotation speed shown in Table 1 below.

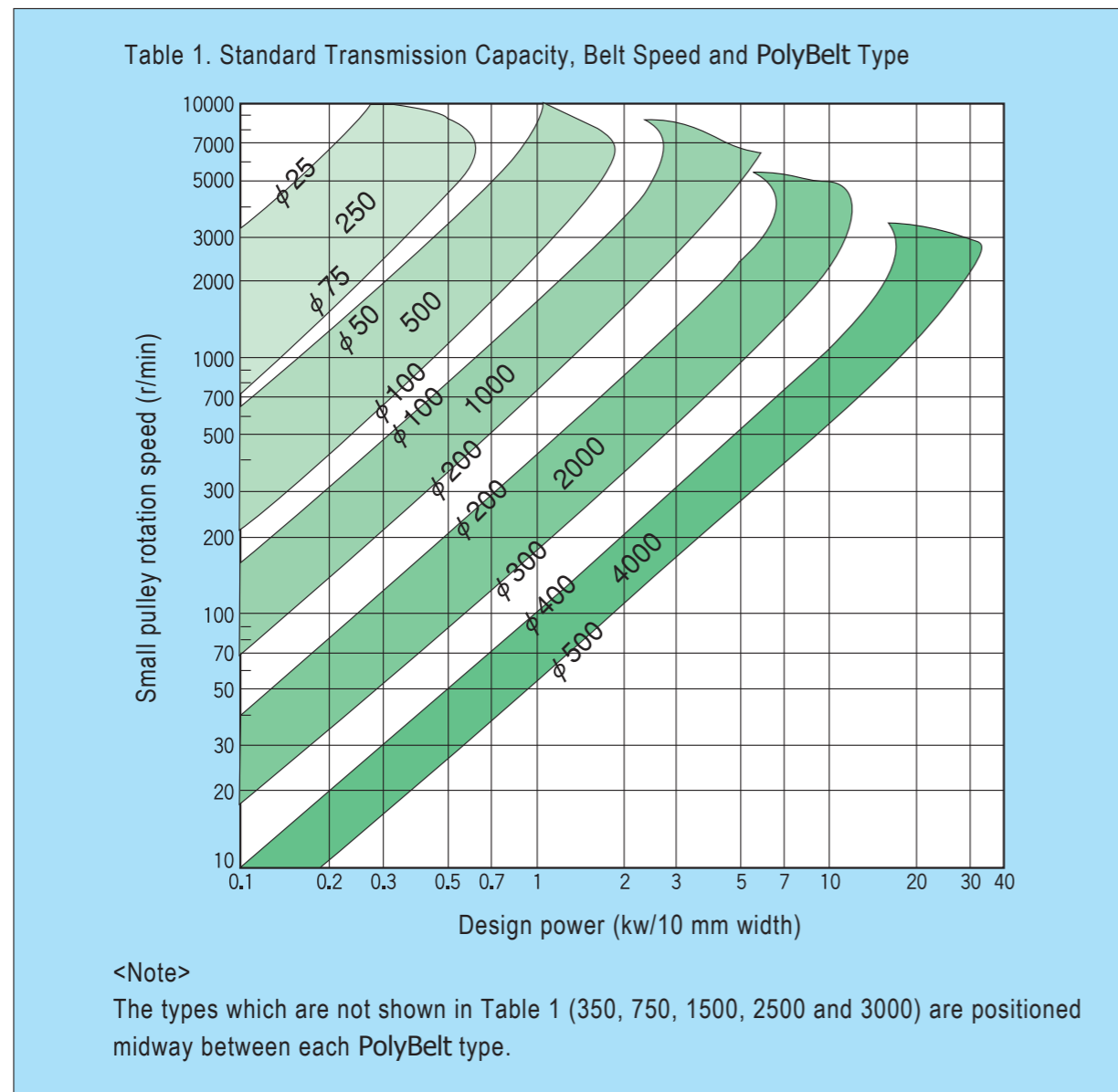

(2) Calculate the belt speed (V) by using the pulley diameter and rotation speed.

$$v(\text{m/s}) = \frac{\pi \cdot d \cdot n}{60 \times 1000}$$

d: Drive pulley diameter (mm)
n: Drive rotation speed (mm)

(3) Calculate the effective tension (Te) by using the transmission power and the belt speed.

$$T_e(\text{N}) = \frac{1000 \times P}{v}$$

P: Transmission power (kw)

(4) Calculate the pulley contact angle (θ) (for the open belt drive).

$$\theta(\text{deg}) = 180^\circ - \frac{57(D - d)}{C}$$

D: Large pulley diameter (mm)
d: Small pulley diameter (mm)
C: Center distance (mm)

(5) Obtain the traction coefficient (λ) from Table 2 below.

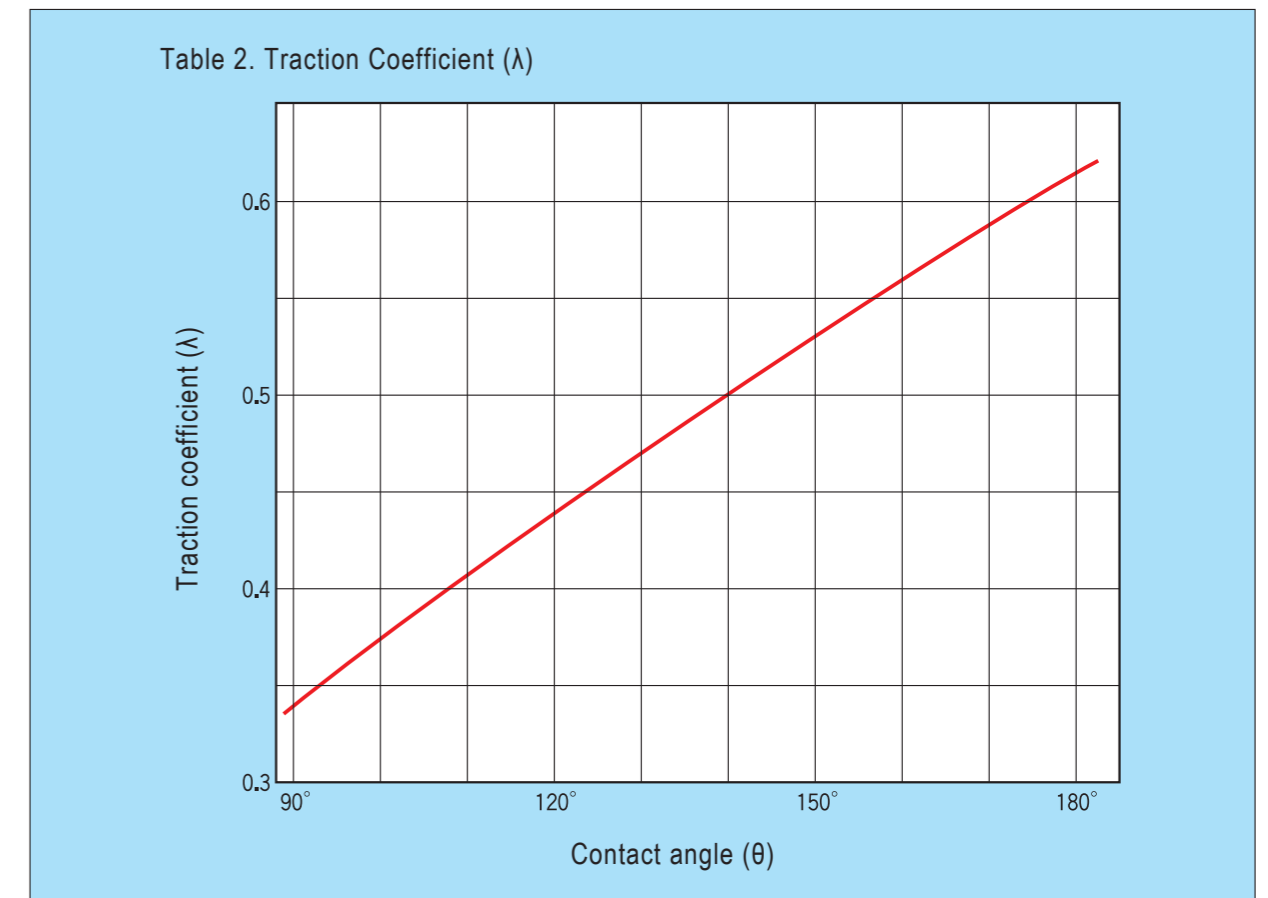

(6) Select the load reserve factor (K) from Table 3 below.

Table 3. Load Reserve Factor (K)

Use conditions	Normal condition	Environment with oil and dust
Excessively light start-up load; small load fluctuation (Belt conveyors and small centrifugal pumps)	1.3	2.4
Light start-up load; small load fluctuation (Printing machines and wood working machines)	1.5	2.7
Heavy start-up load; large load fluctuation (Printing machines, pressing machines and rolling machines)	2.0	3.6

(7) Calculate the approximate axial load (2To).

$$2T_o(\text{N}) = T_e \times \frac{K}{\lambda}$$

(8) Calculate the belt width limit (b).

$$b(\text{mm}) \leq \frac{bp - 10}{1.1}$$

bp: Pulley width (mm)

Round the calculated belt width to the nearest 5 mm.

(9) Obtain the centrifugal constant from Table 4 below. Then calculate the centrifugal tension (t_c) using the following calculation formula.

<Calculation formula> Centrifugal tension (t_c) = Centrifugal tension constant x Belt thickness (h) (mm)

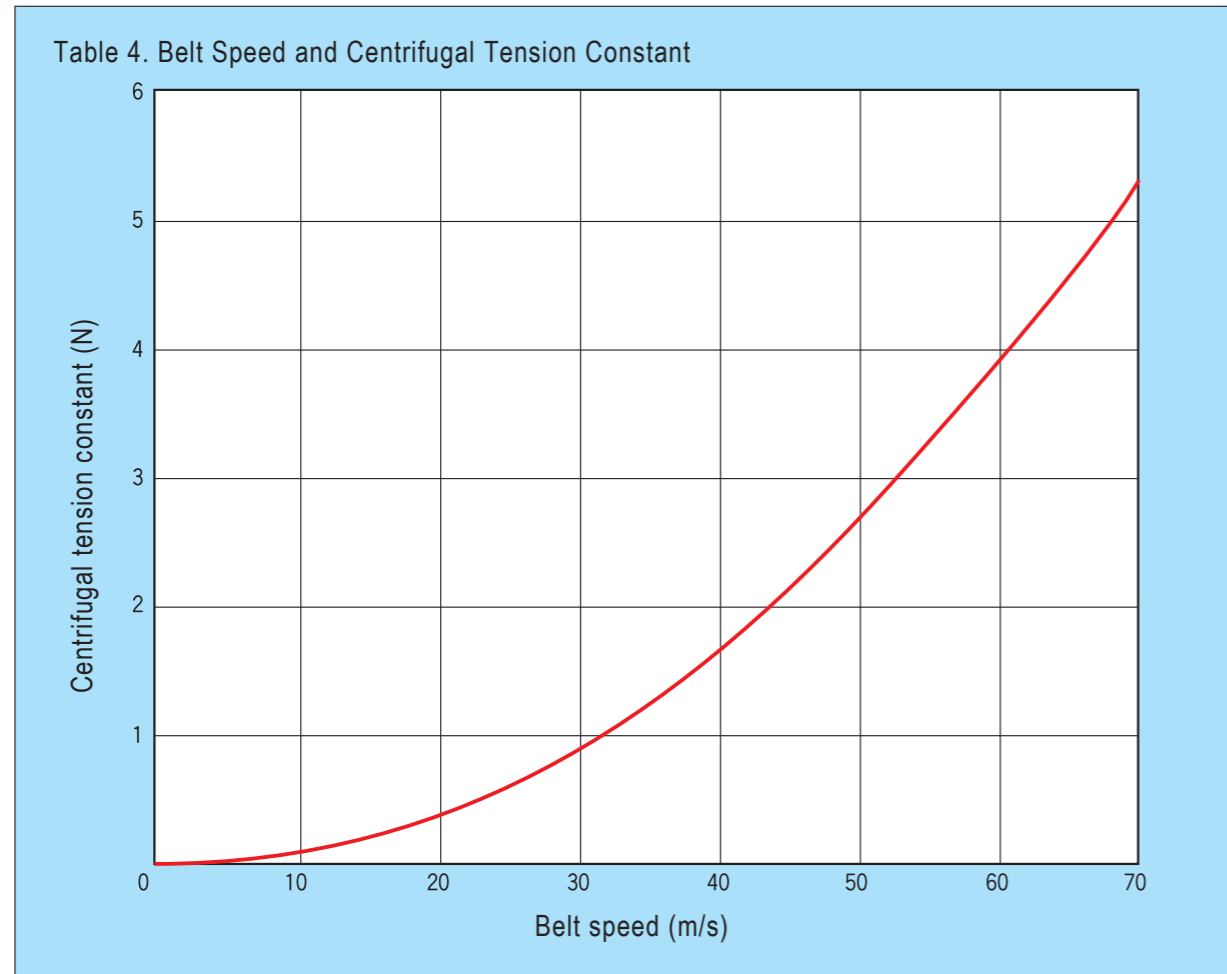

(10) Calculate the axial load ($2t_o$) per unit width (N/mm width).

$$2t_o(\text{N/mm width}) = \frac{2T_o}{b} + 2t_c$$

(11) Calculate the elongation rate (ϵ) of the selected belt.

$$\epsilon = \frac{2t_o}{2t_o(2\%)} \times \epsilon'' \quad \begin{array}{l} \epsilon'' : \text{Standard elongation rate (2 \%)} \\ 2t_o(2\%) : \text{Axial load under stable conditions (N/mm width) at 2 \% elongation} \end{array}$$

The allowable belt elongation rate is 1 - 3 %.

When the belt elongation rate is outside this range, take the following measures.

a. Change the belt type. b. Change the belt width.

(12) Calculate the axial load (F) by using the belt tension.

$$\text{During operation stop: } F_s(\text{N}) = 2t_o \times \frac{\epsilon}{2} \times b \times \sin \frac{\theta \times \pi}{2 \times 180^\circ}$$

$$\text{During operation: } F_r(\text{N}) = \left(2t_o \times \frac{\epsilon}{2} - 2t_c \right) \times b \times \sin \frac{\theta \times \pi}{2 \times 180^\circ}$$

(Note) For multiaxial power transmission and conveyance, please consult Nitta.

2. Belt Length Calculation Formula

Calculate the inner peripheral length (L_i) as follows:

Inner peripheral length (A)

$$L_i(\text{mm}) = 2C + \frac{\pi}{2}(D+d) + \frac{(D-d)^2}{4C}$$

Inner peripheral length (B)

$$L_i(\text{mm}) = 2C + \frac{\pi}{2}(D+d) + \frac{(D+d)^2}{4C}$$

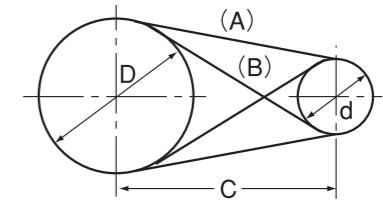

The length of PolyBelt is determined according to the pitch length (L_c). Convert " L_i " obtained above into " L_c ".

$$\text{Pitch length } L_c = L_i + \pi h \quad h: \text{Belt thickness (mm)}$$

When the center distance is fixed and there is no tension pulley in the device, shorten the belt length by the elongation rate as shown in the calculation formula below.

$$\text{Belt length (mm)} = \frac{L_c}{1+E} \quad E = \frac{\epsilon}{100} \quad \epsilon: \text{Elongation rate (\%)}$$

(Note) Please inform Nitta of the pulley diameter and the coordinates; we will calculate the belt length for multiaxial power transmission.

3. Pulley Shape

(1) Calculate the pulley width (b_p) from the following formula.

$$b_p(\text{mm}) = 1.1b + 10\text{mm} \quad b = \text{Belt width (mm)}$$

(2) Obtain the pulley crown (h_c) from Table 5.

Table 5. Standard Crown h_c (mm)

Pulley width \ Pulley diameter	30~150	151~300	301~700	701~1000	1001~1500	1501 or more
30~125	0.8	1.2	1.3	1.7	2.0	2.5
126~260	1.0	1.3	1.5	2.0	2.3	2.8
261~400	1.1	1.4	1.6	2.2	2.5	3.0

(3) Calculate the curvature radius (r_c) from the following formula.

$$r_c(\text{mm}) = \frac{b_p^2}{8h_c}$$

(4) The pulley surface finish is required to be 6.3S or more.

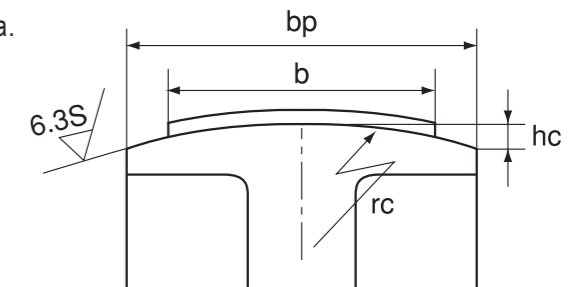

(5) Belt speed and pulley material

Belt speed	30 m/s or less	30 to 50m/s	50 m/s or more
Pulley material	Cast iron, aluminum, mild steel	Cast iron or mild steel	Mild steel

(6) As a rule, do not attach a flange to the pulley.

Precautions for Use

The following are precautions for using PolyBelt.

Belt Tension

Measure the tension mark and stretch the belt to obtain the specified elongation rate. Rotate the belt once or twice to stretch it uniformly and check the tension mark.

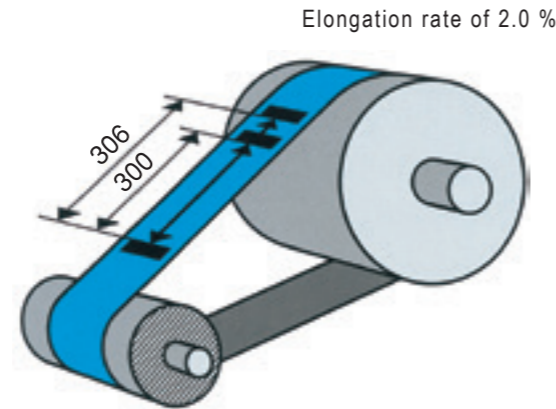

Crossed Belt Drive

PolyBelt is highly abrasion resistant. In order to lengthen the belt life, insert a rotator at the intersection of the belt.



Belt Shifters

Use rotary belt shifters. If the shifters do not rotate, belt abrasion is accelerated. Set the shifters at the positions where the belt enters the driven pulley. When selecting the belt type, consider the shifting property as well as the transmission calculation.

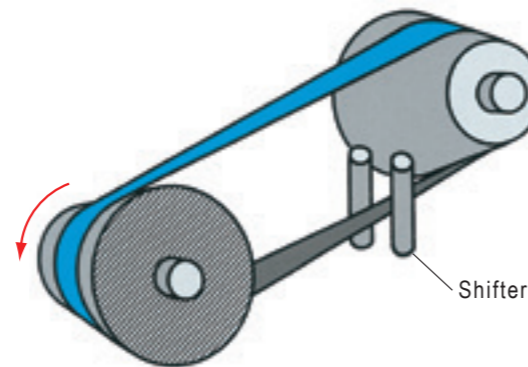

Attaching the Belt

When attaching the belt, use a center-distance adjuster. If the adjuster is not available, cover the pulley edges with waste cloth, etc. to prevent damage to the belt.

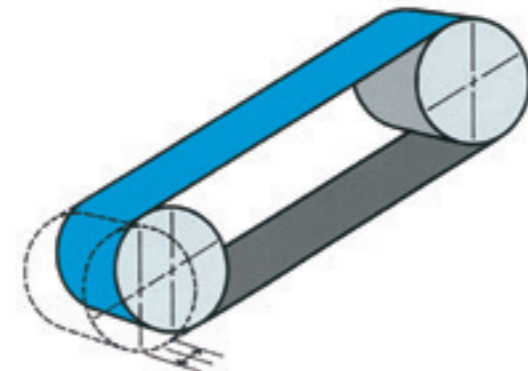

Belt Elongation Rate

The maximum allowable elongation rate for PolyBelt is 3 %. When the belt elongation rate is more than 3 %, use the next highest rank of belt type or a wider belt.

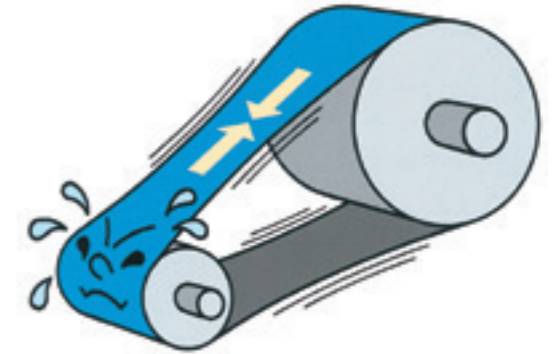

Minimum Pulley Diameter

The minimum pulley diameters of PolyBelt for conveyance are listed in "Types and Properties" on P. 3 to 6. When the belt speed is 5 m/s or less, the minimum pulley diameter for conveyance is in effect.

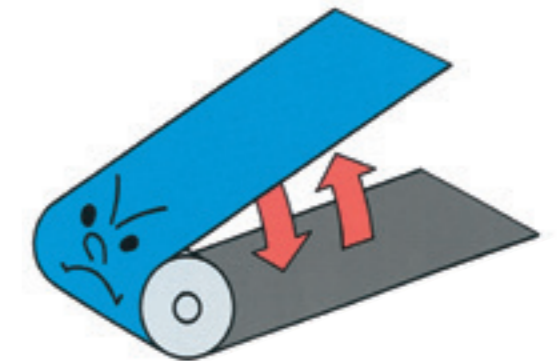

Resistance to Chemicals

PolyBelt is not affected by wetting and drying, machine oil, steam, fat, benzene, etc. However, be aware that PolyBelt is affected by concentrated acids, phenols, ketones and alcohol.

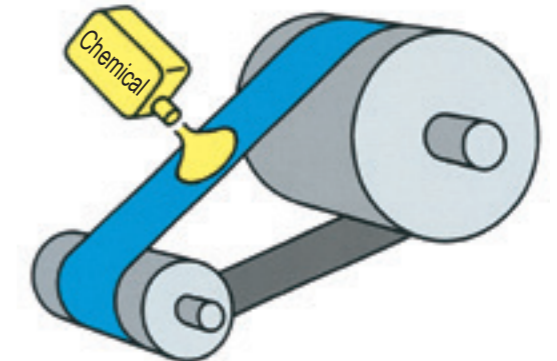

Belt Length

PolyBelt is manufactured according to pitch length. When ordering the belt, specify the pitch length. When ordering the belt to be set at a location where the center distance is not adjustable, specify the pitch length shortened in advance by the specified elongation rate. (See P. 10.)

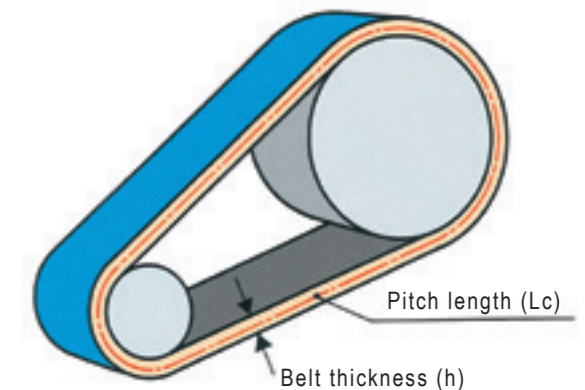

Troubleshooting for Power Transmission Problems

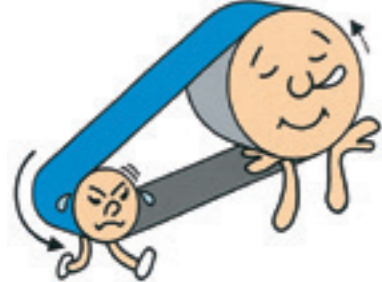
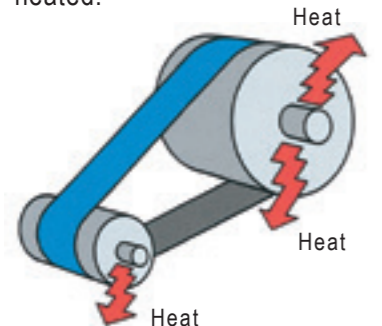
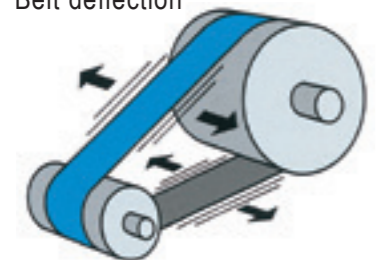

When any of the following failures occur, troubleshoot as follows:

Failure	Failure Diagnosis	Troubleshooting
The belt comes off the pulley. 	The belt deviates at start-up and then returns.	<ul style="list-style-type: none"> The starting torque is too high; tighten the belt further or lower the starting load.
	Normal performance when the load is low; the belt comes off under high load.	<ul style="list-style-type: none"> The load is high; tighten the belt further or lower the load.
	The belt comes off even when the load is low.	<ul style="list-style-type: none"> Correct the pulley parallelism. Tighten the part where the belt comes off. If the tension pulley is used, tilt its axis.
The specified speed is not reached. 	When further tightening the belt, the rotation speed does not increase.	<ul style="list-style-type: none"> Measure the pulley diameter. When the speed ratio is large, add the belt thickness to the pulley diameter. Measure the rotation speed of the driver.
	When further tightening the belt, the rotation speed increases.	<ul style="list-style-type: none"> Check for excessive load. Check the belt tension and the tension rate. Recheck that the belt transmission capacity is appropriate for the load. In an excessively high temperature environment, tighten the belt further.
The bearings are excessively heated. 	Check for excessive tightening of the belt.	<ul style="list-style-type: none"> Check the tension mark or measure the tension with a tensiometer. If the tension is too high, loosen the belt. If the belt is too wide for the load, narrow the belt width.
	The belt tension is appropriate.	<ul style="list-style-type: none"> Select appropriate bearings according to the bearing allowable load and rotation speed. Check for a shortage of lubricating oil.
Belt deflection 	The belt deflects to the pulley axis. (Snaking)	<ul style="list-style-type: none"> When slight snaking of the belt affects functionality, check that the belt is not bent.
	The belt deflects perpendicularly to the direction of the pulley axis. (Waving)	<ul style="list-style-type: none"> The vibration frequency of the machine resonates with that of the natural vibration frequency of the belt; change the belt tension.

For Safe Use of Products

※Before use, carefully read and follow the safety precautions below.

For safe use, this instruction manual and the product use various symbols and signal words. After fully understanding their meanings, read the safety precautions and follow the instructions. ■Improper use ignoring the symbols and the signal words may result in the following risks.

Symbol and Signal Word	Severity of Risk
 DANGER	Indicates matters that may lead to imminent risk of death or serious injury if ignored or incorrectly handled.
 WARNING	Indicates matters that may lead to death or serious injury if ignored or incorrectly handled.
 CAUTION	Indicates matters that may lead to injury and physical damage if ignored or incorrectly handled.

1. Function and Performance

 **DANGER**

- Do not use the belt as hoisting or towing equipment.

 **WARNING**

- Do not use the belt beyond the acceptable ranges specified in the Catalogue.
- When fire and malfunction of the control device are expected due to static electricity generating in the transmission device, use an antistatic belt. Set a neutralization apparatus in the transmission device.
- Do not use the belt for conveying unpackaged food.

- Before maintenance, inspection or replacement, be sure to turn off the switch and check that the machine stops.

 **WARNING**

- When cleaning the belt, do not use chemicals harmful to humans.

 **CAUTION**

- After replacing the belt with a new one, perform a test operation to adjust tension, elongation rate and operation.
- Do not attach the belt forcibly; use a motor slide, a tension pulley or a special pulling device.
- When abnormal noise, snaking, deviation, slipping, etc. occur, stop the belt immediately for inspection.

2. Storage and Shipping

 **WARNING**

- Keep fire away.
- Belt is combustible; do not store or use it near fire or a high-temperature heat source.
- When storing heavy belts, fix them by appropriate jigs or stoppers to prevent falling or rolling.

 **CAUTION**

- When storing and shipping the belts, do not distort them excessively.
- Store the belts in a well-ventilated, low-humidity place free from direct sunlight. The recommended storage temperature is -10 to +30°C.
- Store the belts in the shipping packages.

4. Installation, Endless Processing, etc.

 **WARNING**

- When using solvent or adhesive, fully ventilate the workplace. Keep fire away.

 **CAUTION**

- Perform endless joining of belts by using the materials, the methods and the procedures specified by Nitta.

3. Installation and Daily Use

 **DANGER**

- Be sure to put a safety cover over the rotating part including the belt; hair, gloves or clothes may get caught in the belt pulley.

5. Handling Used Belts

 **WARNING**

- Do not leave the belts near fire.

 **CAUTION**

- Do not burn used belts; harmful gasses may be generated.
- Lawfully dispose of the used belts as industrial waste.

NITTA CORPORATION

4-4-26 Sakuragawa Naniwa-ku, Osaka 556-0022 Japan
Phone:+81-6-6563-1225 Fax:+81-6-6563-1242
<http://www.nitta.co.jp>



NITTA CORPORATION OF AMERICA

7605 Nitta Drive, Suwanee, GA 30024, U.S.A.
Phone:+1-770-497-0212 Fax:+1-770-623-1398
<http://www.nitta.com>

NITTA CORPORATION OF HOLLAND B.V.

Berenkoog 25, 1822 B.H. Alkmaar, The Netherlands
Phone:+31-72-5622234 Fax:+31-72-5613238
<http://www.nitta.nl>

NITTA(SHANGHAI) MANAGEMENT CO., LTD

Room 2705, Shenggao International Building, No. 137 Xianxia Road, Shanghai 200051
Phone:+86-21-6229-6000 Fax:+86-21-6229-9606
<http://www.nitta-cn.com>

NITTA CORPORATION INDIA PVT. LTD.

Gat No. 186, Village Fulgaon, Taluka Haveli, Pune, Maharashtra 412216, INDIA
Phone:+91-20-6731-3400 Fax:+91-20-6731-3401
<http://www.nitta.co.in>

NITTA CORPORATION KOREA OFFICE

Room 710, 7F, Shinhan DM Bldg. Mapo-daero 25, Mapo-gu, Seoul, Korea
Phone:+82-2-3274-1252 Fax:+82-2-3274-1253
<http://www.nitta.kr>

NITTA INDUSTRIES EUROPE GmbH

Hansaallee 201, 40549 Dusseldorf, Germany
Phone:49-211-537535-0 Fax:+49-211-537535-35
<http://www.nitta.de>

NITTA CORPORATION OF SINGAPORE PTE LTD

120 Lower Delta Road, #05-07/08
Cendex Centre, Singapore 169208
Phone:+65-6438-8738 Fax:+65-6438-8793
<http://www.nitta.com.sg>
<Thai Liaison Office>Phone:+66-9-0654-9717
<Indonesia Liaison Office>Phone:+62-878-2292-5633

TAIWAN NITTA FILTER CO., LTD.

Headquarters: Chia Hsin Building 10FL Room No. 1005, 96 Chung Shan North Road Section 2, Taipei, Taiwan, R.O.C.
Phone:+886-2-2581-6296 Fax:+886-3-469-0260
<http://www.nitta.com.tw>

NITTA BRASIL

Rua Francisco Mommenshon, 50B, Galpão 02
Laranjeiras, Caieiras, São Paulo, Brazil
Phone/Fax:+55-11-4441-2922
<http://www.nitta.com.br>

CONNECT CONVEYOR BELTING INC.

405 Industrial Drive Unit 3-8, Milton, Ontario Canada L9T 5B1
Phone:+1-905-878-5552 FAX:+1-905-878-0344
<http://www.connectbelting.com/>